



SPECIFICATIONS

Overall Dimensions	61" L x 30" W (front to back) x 29" H
Water Capacity	
without overflow	N/A
with overflow	31 gallons
Water Depth	
to top of tub	N/A
to overflow	13-1/2" H
Tub Weight Uncrated	300 lbs.
Tub Rim	3" wide
Faucet Configurations	7" Rim Holes No Drillings
Tub Footprint	34" L x 19" W

61" Arabella

Cast Iron Double-Slipper Tub

All measurements are approximate. Measurements may vary +/- 1/2".

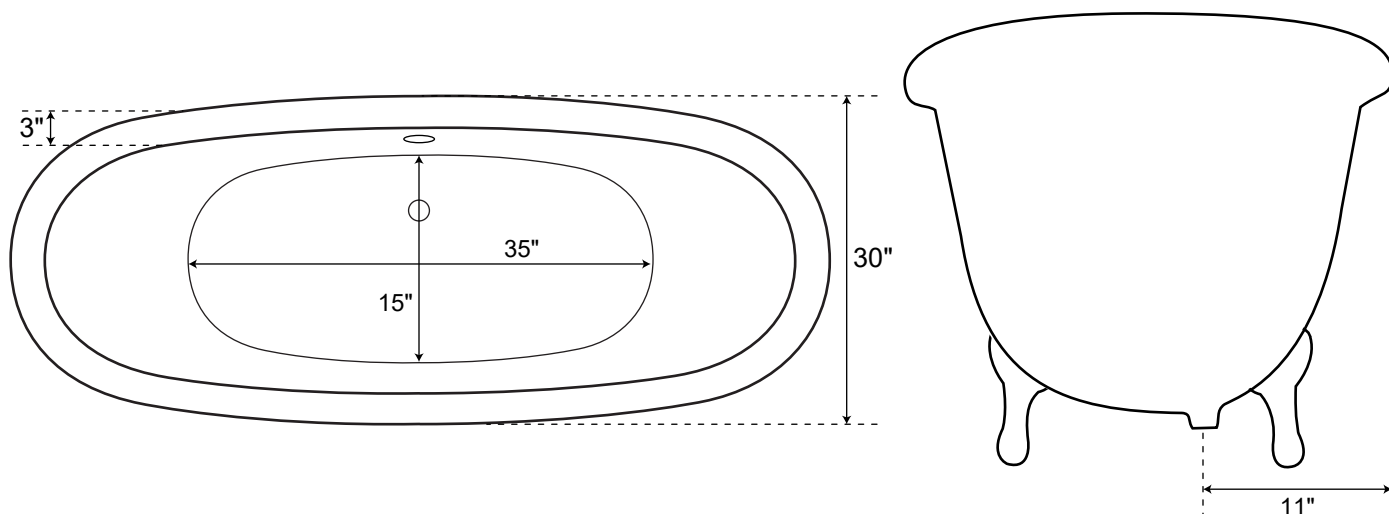
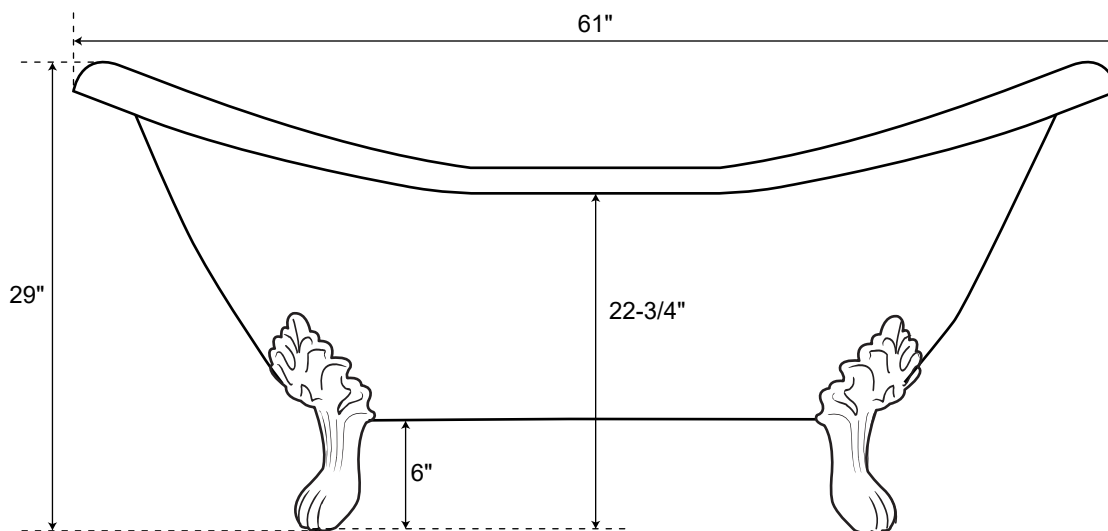



SPECIFICATIONS

Overall Dimensions	71-3/4" L x 31" W (front to back) x 30" H
Water Capacity	
without overflow	N/A
with overflow	37 gallons
Water Depth	
to top of tub	N/A
to overflow	13-1/2" H
Tub Weight Uncrated	300 lbs.
Tub Rim	3" wide
Faucet Configurations	7" Rim Holes No Drillings
Tub Footprint	34" L x 19" W

72" Arabella

Cast Iron Double-Slipper Tub

All measurements are approximate. Measurements may vary +/- 1/2".

